

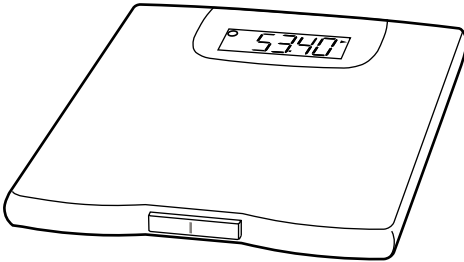

Instruction Manual

Precision Health Scale Model UC-321



Before Use

Precautions	1
Scale Components	2
Display Symbols	3
Installing (or Replacing) Batteries ..	3

Operations

Normal Measurement	4
Memory Function	6
Target Function	8
BMI Indication	10

References

Specifications	12
Maintaining the Scale	12
Before Requesting Service	12

Precautions

- Please read this booklet before using your scale.
- Do not place your scale on a soft, wet or slippery floor.
It is recommended you place your scale on the solid and level floor.
- Your scale contains delicate, high-precision parts. Avoid extremes in temperature, humidity, direct sunlight, shock, moisture and dust.
- Do not step on your scale with your feet wet so as to prevent you from slipping and falling down. It is recommended that you step on the center portion of your scale gently.
- Do not step on the display window.
- Do not open the case of the scale.
- If you press and hold the measurement switch, the battery power is consumed.

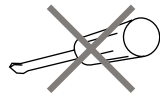

Indications for Use

- The UC-321 was designed for adult use at home.

Compliance with European Directive



The scale complies with the statutory EMC (Electromagnetic Compatibility) directive 89/336/EEC and the Low Voltage Directive 73/23/EEC. **Note: The displayed value may be adversely affected under extreme electromagnetic influences.**

Scale Components

Display

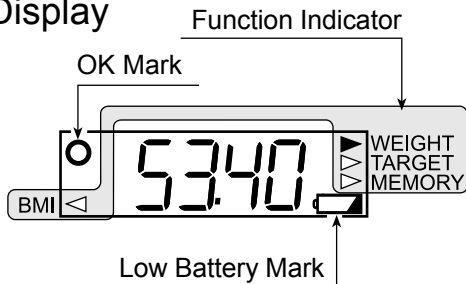

Front

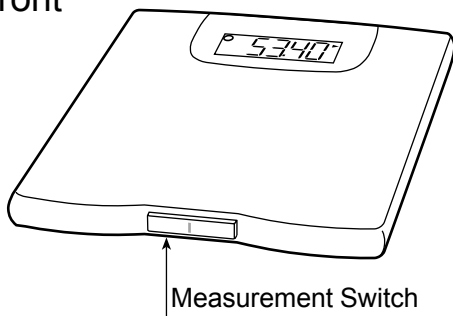

Back

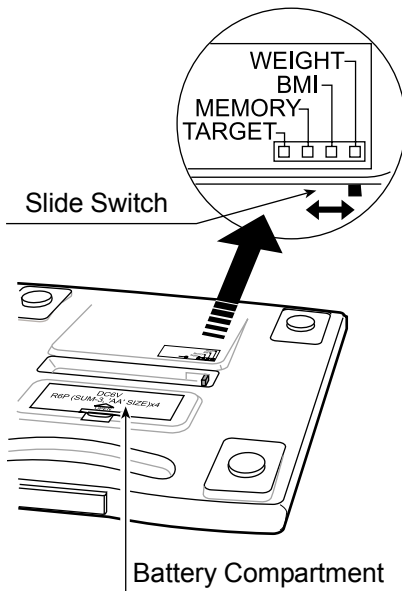

- The following four measurements can be selected by the **function switch**.

WEIGHT	Refer to “Normal Measurement” and “Measuring a baby or an animal”. The function to measure your weight, the weight of a baby or animal.
BMI	Refer to “BMI Indication”. The BMI is a helpful indicator of body weight condition, in adults.
MEMORY	Refer to “Memory Function”. Up to 31 weight data can be stored in memory. The difference from the previous result is displayed automatically.
TARGET	Refer to “Target Function”. The difference between the preset target weight and the current weight can be displayed.



- The scale has the “**automatic-power-off**” function to turn the scale off after no operation for ten seconds. Therefore, the scale has no off switch.

Display Symbols

○	OK mark. This mark is displayed, when measurement display is stable.
	Low battery mark. If this mark is displayed, replace the batteries with new ones.
◀, ▶	Function indication. The current function is indicated.

Installing (or Replacing) Batteries

Caution

- ❑ Insert each battery with its positive (+) and negative (-) terminals properly aligned with the corresponding marks on the scale. If you fail these battery directions, it may cause battery leakage.
- ❑ Replace all four batteries with new ones, when  mark is displayed.
- ❑ Do not mix used and new batteries. It may cause damage to the battery or scale, if used.
- ❑ When batteries are completely drained,  mark is not displayed.
- ❑ The battery life is dependant upon the environmental temperature, battery performance and usage.
- ❑ Remove the batteries from the battery compartment, when the scale is not to be used for a long time. They may leak and damage your scale.
- ❑ The battery life of accessory batteries may be shorter than new ones.

Steps for Installing (or Replacing) Batteries

- 1 Remove the battery compartment cover on the underside of the scale by gently pushing on the arrow and lifting the cover backward.
- 2 Place four new batteries with the positive (+) and negative (-) terminals properly aligned with the corresponding marks on the scale.
- 3 Replace the cover by sliding it into the compartment and gently pressing into place.

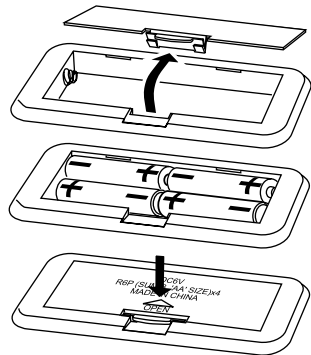

Normal Measurement

Measuring Your Weight

1 **Set the slide switch to “WEIGHT”.**

2 **Press the measurement switch gently.**

All display segments are indicated for several seconds, then displaying 0.00 kg and the  mark..

3 **Step on your scale.**

Step on your scale gently. When the  mark disappears, the measurement is started. Remain still during measurement.

If the condition to display 0.00 kg is maintained for approximately ten seconds, the scale is automatically turned off.

4 **Your weight can be read after the  mark is displayed.**

The scale is turned off automatically after approximately five seconds.

5 **Step off the scale.**

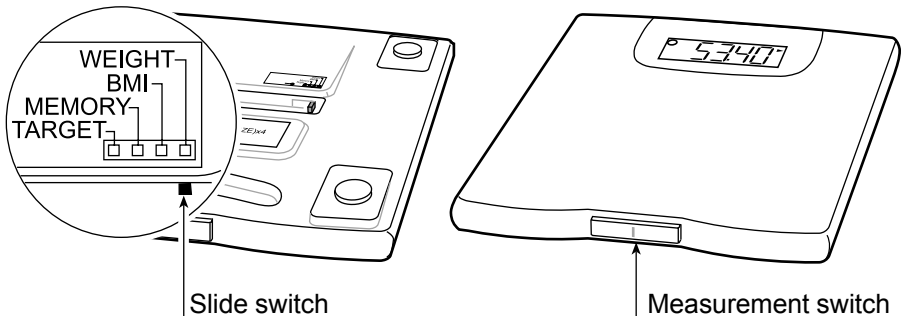
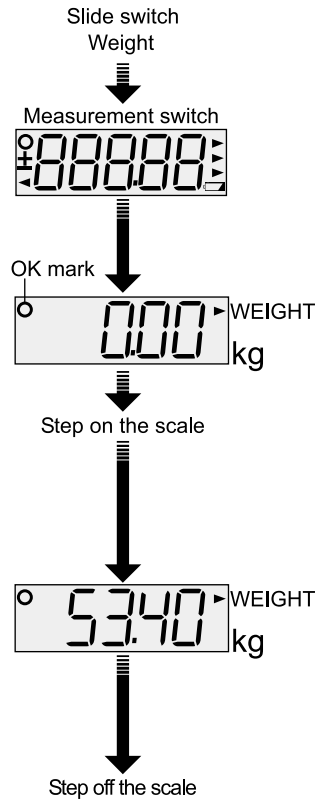



Measuring a Baby or an Animal

1 Set the slide switch to “WEIGHT”.

2 Press the measurement switch gently and step on your scale.

All display segments are indicated for several seconds. Step on the scale without any baby or animal in your hands before displaying 0.00 kg.

3 Pick up the baby or animal and step on the scale again.

Step on your scale with the baby and animal within ten seconds after displaying 0.00 kg and the  mark. Remain still during measurement until displaying  mark.

4 The weight of the baby or animal can be read after displaying the  mark.

The scale is turned off automatically after approximately five seconds.

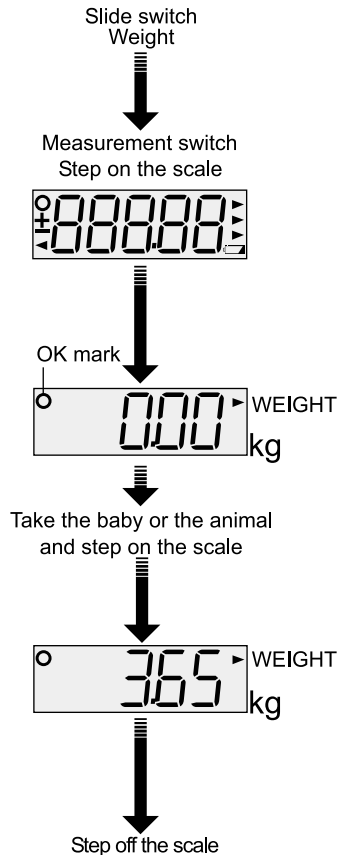

5 Step off the scale.



The Memory Function

Up to 31 weight data can be stored in memory. The 32nd data is stored by deleting the oldest stored data. The difference from the previous result is displayed automatically.

Storing a Current Weight.

- 1 **Set the slide switch to “MEMORY”.**
- 2 **Press the measurement switch gently.**
The last weight is displayed.
- 3 **Step on your scale.**
Step on your scale gently, after displaying 0.00 kg and the  mark. When the  mark disappears, the measurement is started. Remain still during measurement.
If the condition to display 0.00 kg is maintained for approximately ten seconds, the scale is automatically turned off.
- 4 **The weight can be read after the  mark is displayed.**
- 5 **Step off the scale.**
- 6 **The weight is stored in memory and the difference from the last weight is displayed.**

The weight data is stored in memory and the difference from the previous result is displayed for approximately five seconds. And, the scale is automatically turned off.

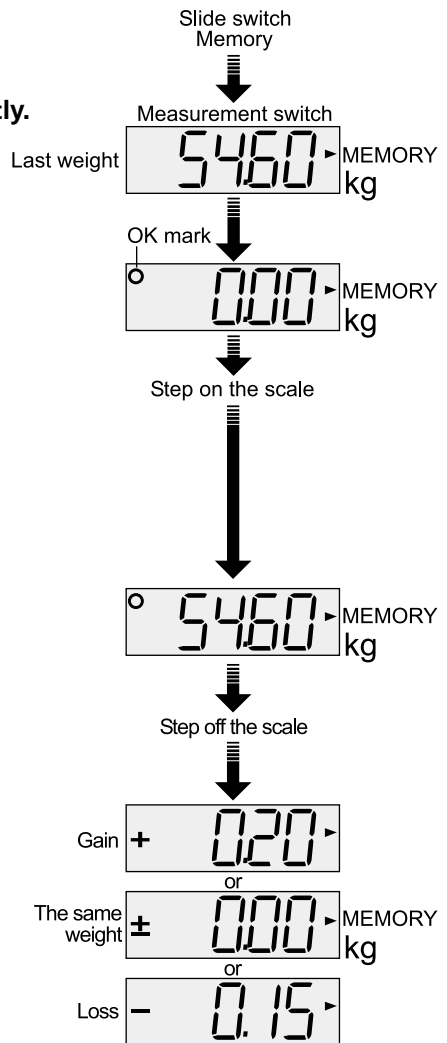

Displaying Weight Data Stored in the Scale

The stored measurement data is displayed in order beginnings with the most recent measurement.

1 Set the slide switch to “MEMORY”.

Slide switch
Memory



2 Press and hold the measurement switch gently in the condition of turning off the scale.

Press and hold
measurement switch



Weight data are displayed in order from the last result. The scale is automatically turned off. If you want to stop the display, press the measurement switch.

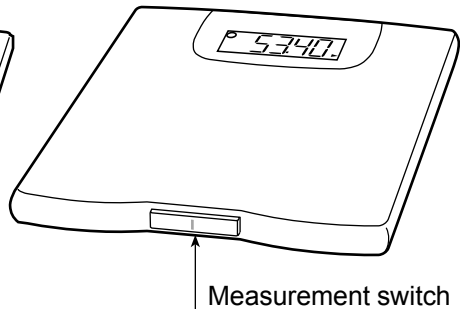
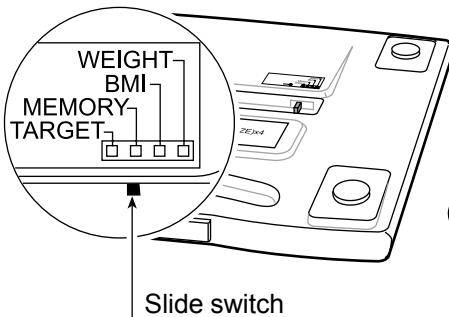
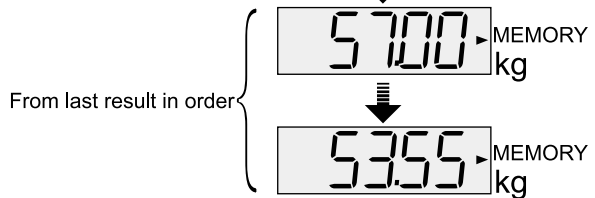

The Target Function

The difference between the preset target weight and the current weight can be displayed.

Presetting a New Target Weight

- 1 Set the slide switch to “TARGET”.**
- 2 Press and hold the measurement switch gently in the condition of displaying nothing.**
The last preset target weight is displayed.
- 3 Press the measurement switch gently to display a new target weight.**
Press and hold the measurement switch to increase the display, until the desired value is indicated to specify a new target weight.

- 4 Release the measurement switch to store the new target weight, when displaying it.**
The scale is automatically turned off after displaying a new target weight for approximately five seconds.

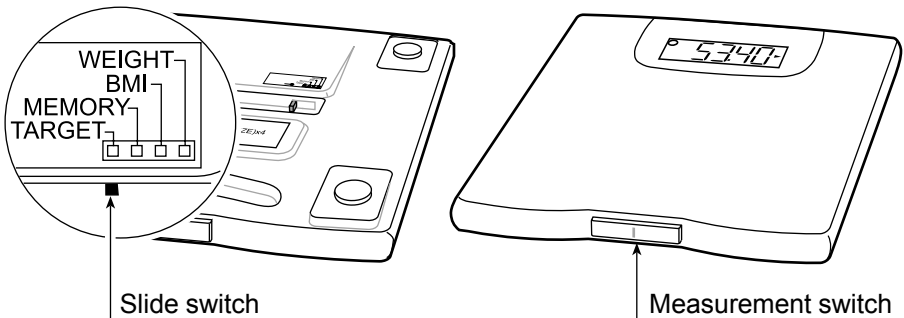
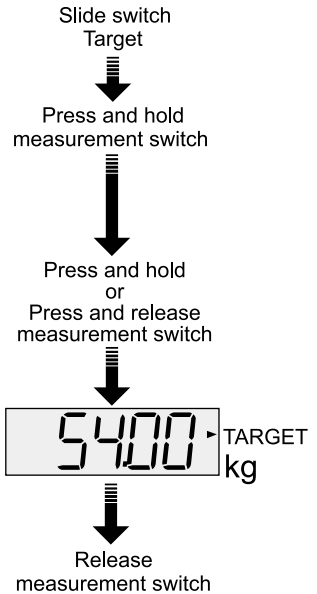

Comparing a Current Weight with a Preset Target Weight

1 Set the slide switch to “TARGET”.



Slide switch
Target

2 Press the measurement switch gently.

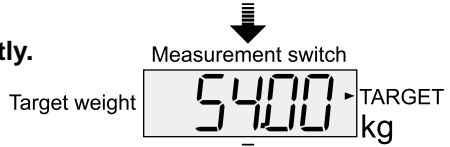
The stored target weight is displayed.



3 Step on the scale.

Step on your scale gently after displaying 0.00 kg and the  mark. When the  mark disappears, the measurement is started. Remain still during measurement.

If the condition to display 0.00 kg is maintained for approximately ten seconds, the scale is automatically turned off.



Step on the scale

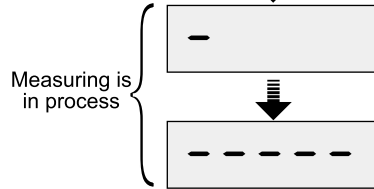

4 The difference between the preset target weight and the current weight is displayed.

The scale is automatically turned off after the difference has been displayed for approximately five seconds.

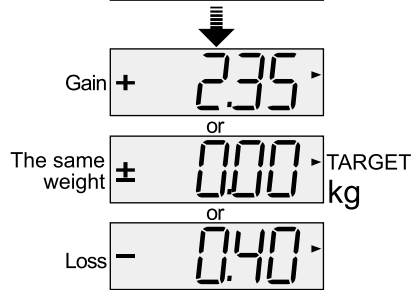

5 Step off the scale.

Step off the scale

BMI Indication

BMI

Body Mass Index or BMI (kg/m^2), based on an individual's height and weight, is a helpful indicator of underweight, overweight or obesity, in adults.

According to the new NHLBI (National Institutes of Health) guidelines, the BMI score means the following list.

Underweight	Below 18.5
Normal	18.5 to 24.9
Overweight	25.0 to 29.9
Obesity	30.0 and Above

$$\text{BMI} = \frac{\text{Weight (kg)}}{\text{Height (m)} \times \text{Height (m)}}$$

Presetting Your Height

Store your height before measuring your weight to calculate the BMI.

The scale can store a height between 30 cm and 220 cm in increments of 0.1 cm.

- 1 Set the slide switch to "BMI".**
- 2 Press and hold the measurement switch gently in the condition of displaying nothing.**
The preset height is displayed.
- 3 Press the measurement switch gently to display a new height.**
Press and hold the measurement switch to increase the display, until the indicated value is correct, to specify a new target weight.
- 4 Release the measurement switch to store a new height, when displaying it.**
The scale is automatically turned off after displaying the new height for approximately five seconds.

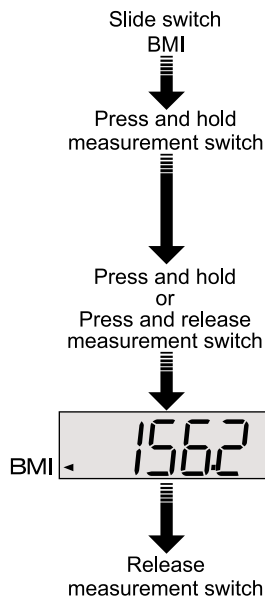



Displaying the BMI Score

1 **Set the slide switch to “BMI”.**

2 **Press the measurement switch gently.**

The preset height is displayed.

3 **Step on the scale.**

Step on your scale gently after displaying 0.00 kg and the  mark. When the  mark disappears, the measurement is started. Remain still during measurement.

If the condition to display 0.00 kg is maintained for approximately ten seconds, the scale is automatically turned off.

4 **The preset height and calculated BMI score is displayed alternately.**

The scale is automatically turned off after displaying them for approximately ten seconds.

5 **Step off the scale.**

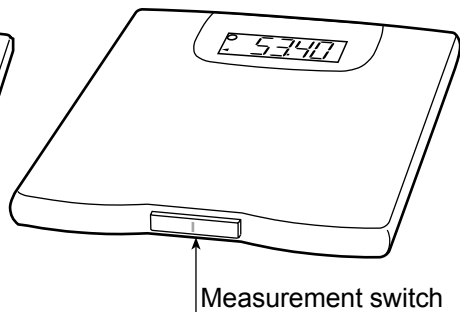
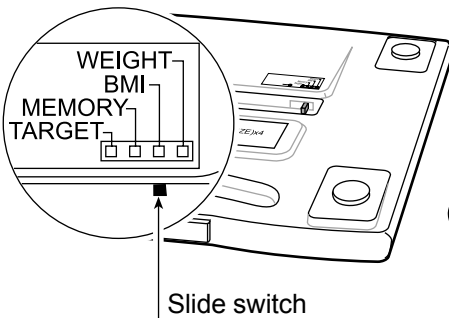
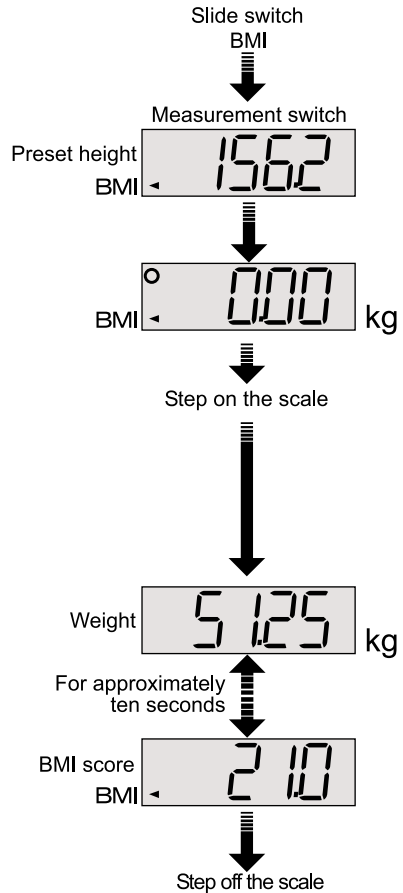

Specifications

Digital display	Liquid crystal display, 25 mm character height
Maximum capacity	150 kg
Minimum display	0.05 kg
Power source	Four type AA batteries (R6P, 1.5 volt x 4)
Battery life	Approximately 2000 measurements
Accessories	Instruction manual

Specifications are subject to change without prior notice and any obligation on the part of the manufacturer.

Maintaining the Scale

- Clean the scale with a dry, soft cloth or a cloth moistened with water and a mild detergent. Never use alcohol, benzene, thinner or other harsh chemicals to clean the scale.
- Remove the batteries, if the scale is not going to be used for a long time.

Before Requesting Service

If this happens	Please do this
Nothing is displayed by pressing the measurement switch.	Check the battery installation. Replace with four new batteries.
The indication is fixed to <i>88888</i> . <i>H</i> or <i>L</i> is displayed.	Remove and reinstall the batteries.
The difference between an estimated weight and a measured weight is bigger.	Move your scale to a flat, solid surface. Does the under case touch to the floor?
<i>E - 0</i> is displayed.	Replace batteries and try again.

If you can not locate and fix the problem, contact your supplier, or the A&D service group. The A&D service group will support authorized suppliers about technical information, spare parts and units.

A&D Co.,LTD.

1-243 Asahi, Kitamoto-shi, Saitama, 364-8585 JAPAN
Telephone: [81] (485) 93-1111 Fax: [81] (485) 93-1119

A&D INSTRUMENTS LTD.

<Authorized Representative Established in the European Community>

Unit 24/26 Blacklands Way, Abingdon Business Park, Abingdon, Oxon OX14 1DY United Kingdom
Telephone: [44] (1235) 550420 Fax: [44] (1235) 550485